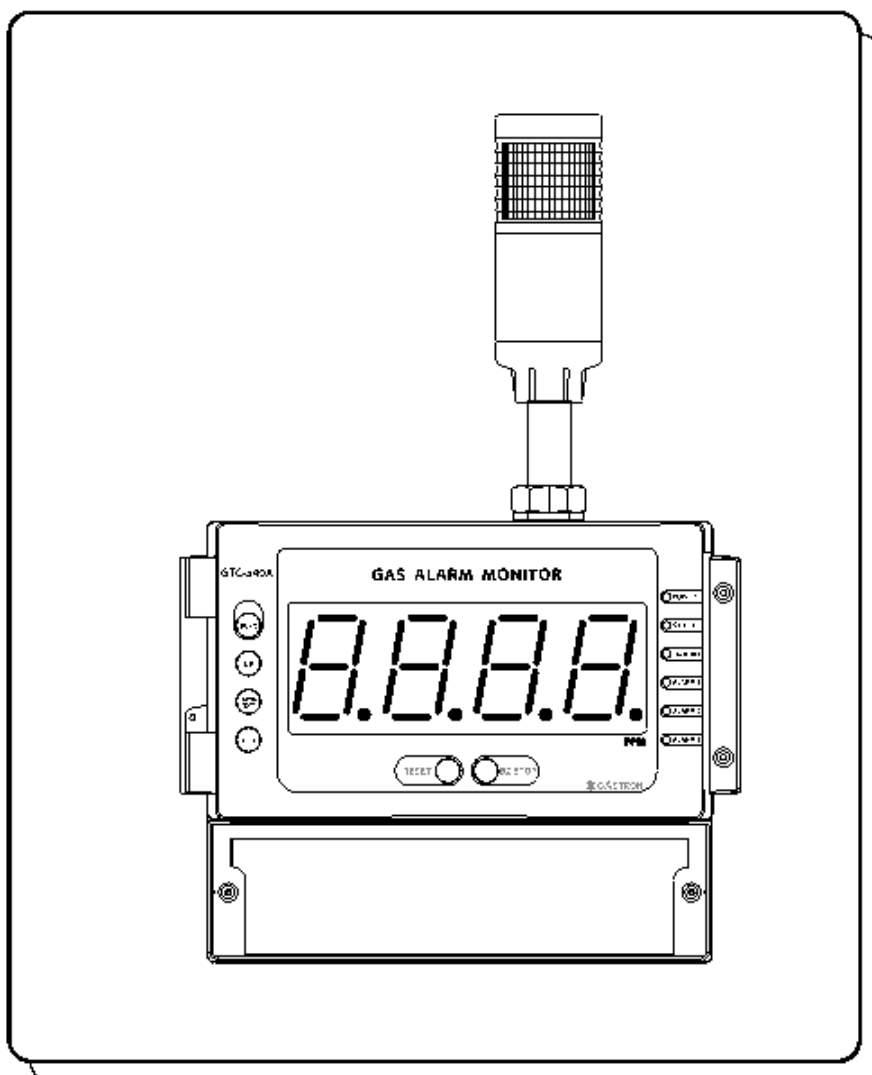

Human Technology & Future

INSTRUCTION MANUAL

GTC-540A

Revision: 1

**GASTRON**

Please read this manual carefully for the correct use of the equipment

Thank you for buying the product of Gastron.

We, Gastron Co., Ltd., is the company specialized in gas detector and gas monitoring system and have been recognized by the clients with the best quality and the convenience of use. We are researching and making efforts continuously so that the clients can find the desired product close to them and to develop the gas detector, which satisfies the clients. From now on, solve all the problems related to the gas detector with the products of Gastron. We will satisfy you taking responsibility.

In this manual, the installation, operation, simple maintenance methods, etc. for the control unit of the GTC-540A Gas Leak Alarm. Please read carefully and keep well and it will provide great help when you have any doubt during the operation.

When any abnormality may occur after buying our products, please contact to below address.

- **Address: Gastron Co., Ltd. 18-8 Dongeumdanji 1-gil (Palgok 2-dong), Sangnok-gu, Ansan City, Gyeonggi-do**
- **Tel : 031-490-0800**
- **Fax : 031-490-0801**
- **URL : www.gastron.com**
- **e-mail : gastron@gastron.com**

Caution

- For the accurate operation of the receiver unit, we recommend to calibrate once within 6 months.
- If this equipment may be needed to disassembled, it should be made by those who have professional skills for the receiver unit.
- For the contents related to the maintenance and the calibration of the receiver unit, please contact with the technical department or use e-mail or web site.

TABLE OF CONTENTS

| | |
|---|----|
| 1. Overview | 4 |
| 2. Structure | 4 |
| 3. Specification | 5 |
| 4. Name of Each Part and Major Function | 6 |
| 4.1. Component..... | 6 |
| 4.2. Detailed Explanation of Each Part..... | 7 |
| 5. Terminal Connection Diagram..... | 9 |
| 5.1. Power Supply Connection..... | 9 |
| 5.2. Reference Diagram for Signal I/O Terminal CN6 Connection | 10 |
| 5.3. Reference Diagram for Signal Output Terminal CN5 Connection | 10 |
| 5.4. Connection between GTC-540A Receiver Unit and Detection Unit | 11 |
| 6. Menu Table | 12 |
| 7. Operation | 14 |
| 7.1. Connection Check | 14 |
| 7.2. Power ON..... | 14 |
| 7.3. Gas Concentration Display | 14 |
| 7.4. Password Input | 15 |
| 7.5. Program Data Setting..... | 15 |
| 7.6. Alarm Data Setting..... | 17 |
| 7.7. Option Setting..... | 20 |
| 7.8. Test Mode Setting..... | 21 |
| 7.9. Maintenance Function Setting..... | 22 |
| 7.10. Test Function Setting..... | 24 |
| 7.11. DOWN (Stand-by) Mode | 24 |
| 7.12. Factory Initialization Function..... | 24 |
| 7.13. Calibration Data Initialization | 25 |
| 8. RS485 MODBUS Communication Data..... | 26 |
| 8.1. 4~20mA Current Output..... | 26 |
| 8.2. 485 MODBUS Interface | 26 |
| 8.2.1. RS-485 Communication Setting..... | 26 |
| 8.2.2. Address Structure..... | 26 |
| 9. Outside View and Dimensions..... | 27 |
| 10. Revision History..... | 29 |

1. Overview

GTC-540A receiver unit adopts the high performance A/D converter and micro-process and is equipped with diverse functions.

GTC-540A receiver unit is independent receiver unit connected with one detection unit, protected by case using ABS material and displays the concentration with FND digital display and 3-color bar graph LED.

It has primary alarm, secondary alarm and tertiary alarm function and failure alarm function.

2. Structure

GTC-540A Independent receiver unit displays the alarm with audio signal (buzzer) and visual signal (Alarm LED) and has the function to hold the maximum measured values when the alarm is activated

Since GTC-540A receiver unit allows the remote control to reset alarm and has output for the alarm (SPDT contact), the gang control function can be performed.

GTC-540A receiver unit provides the 4-20mA DC of output for the measured value and allows digital communication using RS-485 communication signal (Option).

3. Specification

| No | I T E M S | S P E C I F I C A T I O N |
|----|-----------------------|---|
| 1 | Model | GTC-540A |
| 2 | Operation display | 6-LED(Power, 3-alarm, Trouble, Stan-by for Maintenance) |
| 3 | Measuring display | 4-Digit 1.8" FND |
| 4 | Measuring range | 1~9999 (Programmable) / %LEL , %volume , ppm |
| 5 | Alarm display | <ul style="list-style-type: none"> ✓ Visual display: 3-Alarm, Trouble LED, Mars light ✓ Audio display: Buzzer signal |
| 6 | Alarm output Signal | ✓ 3-stage Alarm, Trouble/ AC250V 5A Relay contact(SPDT) |
| 7 | Alarm level set | Set the program within measuring range |
| 8 | Input signal | 4~20mA DC(2wire or 3wire) |
| 9 | Output signal | <ul style="list-style-type: none"> ✓ 4~20mA DC ✓ Isolated RS-485 Modbus(Option) |
| 10 | Reset signal | Reset switch and remote control |
| 11 | Program set mode | <ul style="list-style-type: none"> ✓ Set strength and type of alarm (1,2,3 alarm) ✓ Set time of alarm (immediate & delayed (1~60 sec)) ✓ Alarm range (Dead band) ✓ Compensate the measured value (SAD) ✓ Set relay output to on/off |
| 12 | Operating temperature | -20°C ~ +50°C |
| 13 | Operating humidity | 0~99%.RH(non-condensing) |
| 14 | Operating power | <ul style="list-style-type: none"> ✓ AC85~260V / 3.6W ✓ 24V DC (Option) ✓ Current Consumption Minimum: 50mA (While the gas concentration is displayed, gas value 0) Maximum: 180mA(while gas concentration is displayed, gas value Over) (Buzzer: 25mA, Relay: each 20mA for Alarm 1,2,3) ✓ And when the Mars light or product is added, the current consumption is increased |
| 15 | Dimensions | 235X355X117 |
| 16 | Weight | 1.38Kg |

4. Name of Each Part and Major Function

4.1. Component

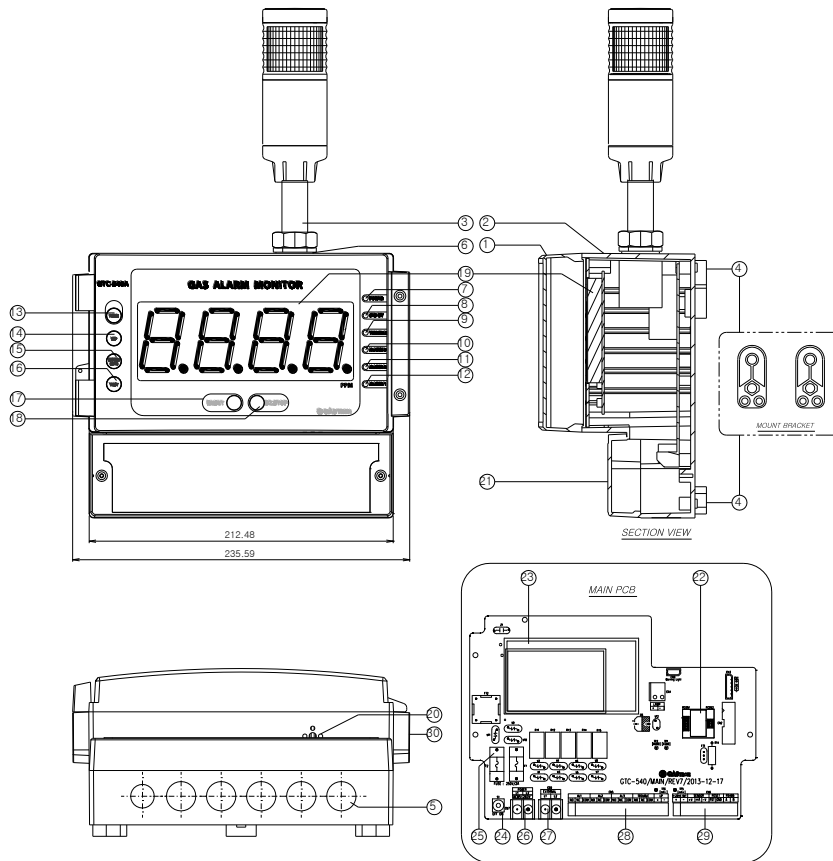

| No. | Descriptions | | |
|-----|--|----|--|
| 1 | Case Front | 16 | TEST S/W |
| 2 | Case body | 17 | RESET S/W |
| 3 | Mars Light | 18 | Buzzer Stop S/W |
| 4 | Mount Boss(2- Ø6.5) | 19 | LCD PCB Ass'y |
| 5 | Conduit connection (1- Ø16.5, 5-Ø20.5) | 20 | Buzzer |
| 6 | O-Ring <NBR> | 21 | Terminal Block Cover |
| 7 | Power LED | 22 | RS-485 module(Optional) |
| 8 | Maintenance LED | 23 | SMPS |
| 9 | Trouble LED | 24 | Power ON/OFF S/W |
| 10 | Alarm 3 LED | 25 | Fuse |
| 11 | Alarm 2 LED | 26 | Input Power Terminal (CN7) |
| 12 | Alarm 1 LED | 27 | External Mars light power Terminal (CN9) |
| 13 | Function S/W | 28 | Signal output terminal (CN5) |
| 14 | UP S/W | 29 | Signal I/O terminal (CN6) |
| 15 | DOWN S/W (Stand-by) | 30 | Cover Fixing Hook |

[Abbreviation Table for Name in Diagram]

4.2. Detailed Explanation of Each Part

| | | |
|---|---|--|
| 1. Case cover | Made of ABS material, and fix the display and protect the circuit from surrounding environment and the external shock. | |
| 2. Case body | Made of ABS material and fix the main PCB and protect the circuit from surrounding environment and the external shock. | |
| 3. Mars light | When alarm is activated, Mars light is turned on. | |
| 4. Mount hole(2-Ø6.5) | This is the hole to fix the control unit to external wall or other mounting plate | |
| 5. Conduit connection (1-Ø16.5, 5-Ø20.5) | Total 6 holes of Ø16.5 and Ø 20.5 are made at the bottom. Connect the power cable, signal cable, etc. using the cable inlet according to the site condition. | |
| 6. O – Ring <NBR> | Prevent the water from penetrating inside. | |
| 7. Power LED | Power LED is turned on when the power is put in. | |
| 8. Maintenance LED (Stand-by LED) | When the detector is in maintenance mode, STD-BY LED is flickering. | |
| 9. Trouble LED | When the trouble in the receiver unit and detection unit occurs, trouble LED is turned on. Ex) * When occurring the defective connection with detection unit or abnormality | |
| 10. Tertiary alarm LED (Alarm 3 LED) | When tertiary alarm is activated, Alarm 3 LED is turned on. If the value reaches to the value for tertiary alarm when performing test function, Alarm 3 LED is turned on. | |
| 11. Secondary Alarm LED (Alarm 2 LED) | When secondary alarm is activated, Alarm 2 LED is turned on. If the value reaches to the value for secondary alarm when performing test function, Alarm 2 LED is turned on. | |
| 12. Primary Alarm LED (Alarm 1 LED) | When primary alarm is activated, Alarm 1 LED is turned on. If the value reaches to the value for primary alarm when performing test function, Alarm 1 LED is turned on. | |
| 13. “FUNC” S/W | “FUNC” S/W is the key to enter the data by switching and selecting the functions such as alarm value setting, alarm type setting, alarm dead band setting, etc. | |
| 14. “UP” S/W | This is the function S/W and is used to raise the set value or to select the next set value. When setting the range of set values greatly, the set value is changed quickly if ‘UP’ S/W is being pressed for a while. | |
| 15. “DOWN” S/W | This is the function S/W and is used to reduce the set value or to select the previous set value. When setting the range of set values greatly, the set value is changed quickly if ‘DOWN’ S/W is being pressed for a while. | |
| 16. “TEST” S/W | If “TEST” S/W is pressed, the mode is changed to the mode performing self-diagnosis. FND for measured value is flickering and is the function to check the alarm operation by adjusting the measured value using “UP” S/W and “DOWN” S/W. Self-diagnosis is reset if the “RESET” S/W is pressed | |
| 17. “RESET” S/W | It performs alarm reset, self-test reset, program setting reset, etc. | |
| 18. “BZ-STOP” S/W | When the alarm is activated, it is used to stop the buzzer. | |
| 19. LCD PCB Ass’y | It displays the measured value of the detector continuously When the test is performed, the value set by the user is displayed flickering. | |

| | | |
|--|---|--|
| 20. Buzzer | When the alarm and the trouble alarm are activated and test is performed, The buzzer is sounded consecutively. | |
| 21. Terminal Block Cover | To supply the power to the product, open the cover and connect the power cable. | |
| 22. RS-485 Communication Module (Option) | RS-485 Communication Module is the isolation type and can exchange the current concentration, set value, etc. connected with PC or other external communication equipments. | |
| 23. SMPS | This is the device converting 220V-AC to 24V-DC. | |
| 24. Power ON/OFF S/W | This is the switch used to turn the control unit power ON and OFF and when performing the works such as cable connection, etc, its power should be turned off. | |
| 25. Fuse | It works as interrupter protecting the product by cutting off the fuse with the heat generated when the over current is running. | |
| 26. Power Input Terminal | This is the terminal to connect the power cable for control unit operation. | |
| 27. External Mars Light Terminal | This is subsidiary terminal to install external Mars light when this control unit is in operation. | |
| 28. Signal output terminal | This is used to connect the relay dry contact signal output such as alarm and failure, etc. and the interrupter signal output cable, etc. | |
| 29. Signal I/O terminal | This is used to connect cable for the power supply of gas leak detector, 4-20mA current output, RS-485 MODBUS communication, etc. | |
| 30. Cover Fixing Hook | This is the device to fix the cover on the case body and pull the cover while pressing the hook to open the cover | |

5. Terminal Connection Diagram

5.1. Power Supply Connection

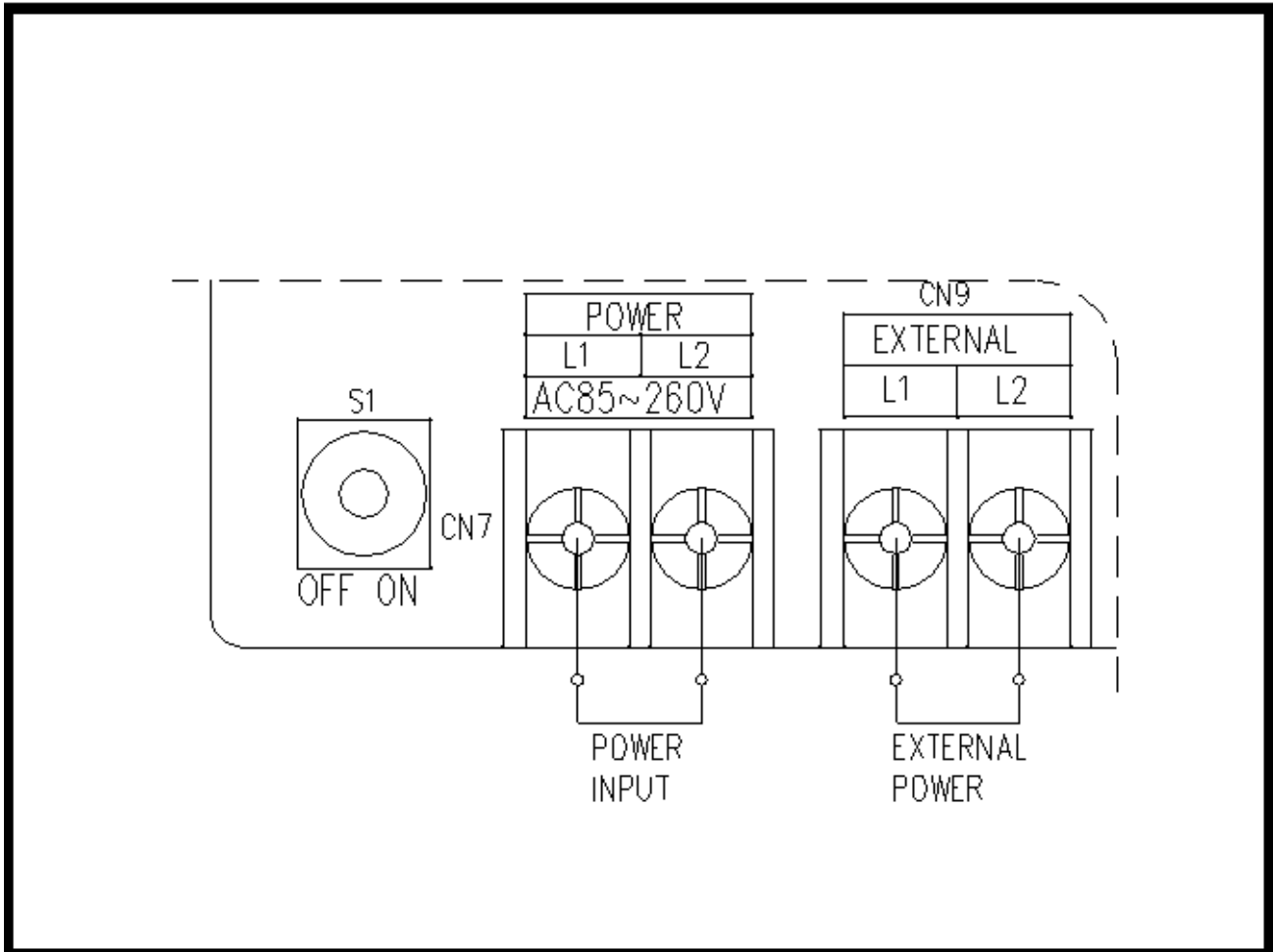

Connect the AC power (85~260V 50/60Hz) to CN7 as shown in figure.

(In case of using DC24V, it should be requested separately when ordering the product, and when the DC24V type of product is delivered according to the user's request, the positive of DC24V should be connected to L1 of CN7 and the negative to L2.

5.2. Reference Diagram for Signal I/O Terminal CN6 Connection

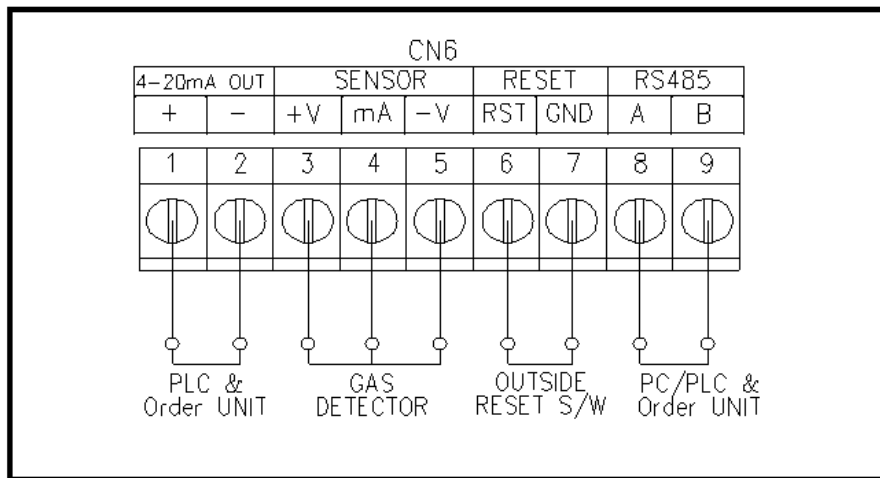

Caution) RS-485 Cable should be used dedicated RS-485 cable and for the connection cable to connect with 4~20mA output and detector, the shield cable of CVVS or CVVSB higher than 0.75sq should be used!

5.3. Reference Diagram for Signal Output Terminal CN5 Connection

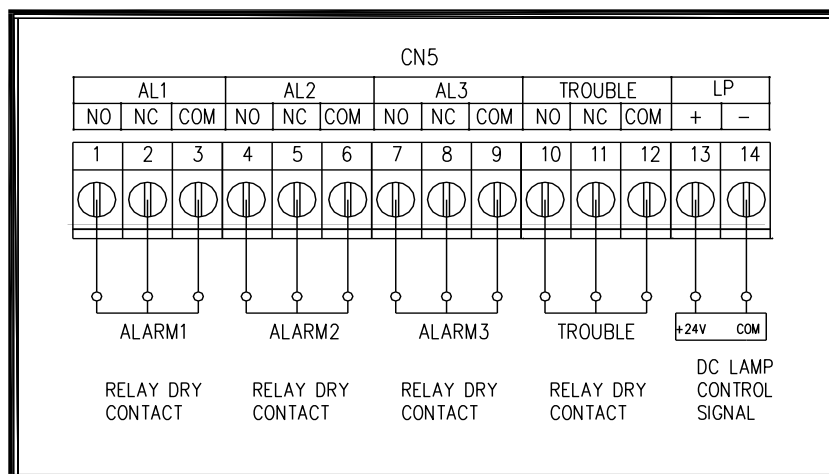

- AL1, AL2, AL3, TROUBLE display the relay contact signal when the alarm is activated or trouble occurs.
- Alarm Lamp (LP) can be connected with External DC Mars light.
- Only the Mars light designated by Head Office can be connected with CN4, which is operated same as LP.

5.4. Connection between GTC-540A Receiver Unit and Detection Unit

For the connection with detection unit, the shield cable higher than 0.75 sq of CVVS or CVVSB is used.

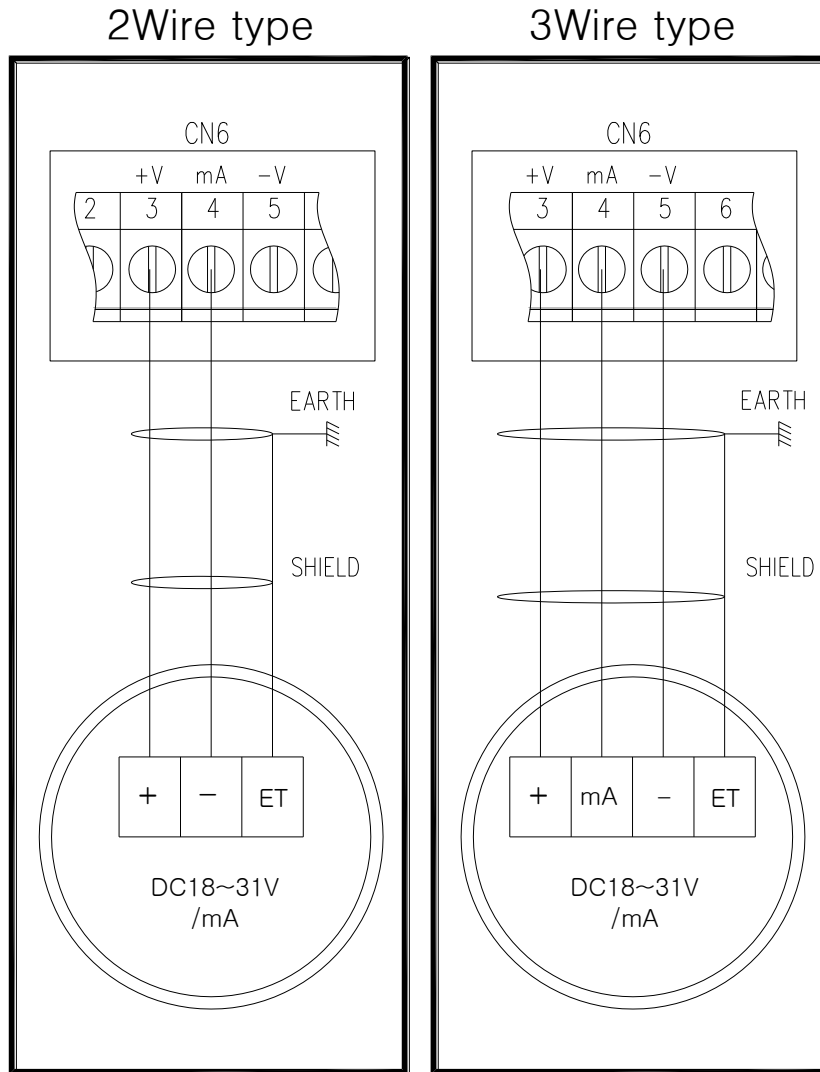

6. Menu Table

| Level1 | Level2 | Level3 | Level4(Selection Range) | Default | |
|--|--|---|---------------------------|--------------|----------|
| FUNC→ | FUNC→ | FUNC → | FUNC → NEXT | | |
| ↑ U P & D O W N ↓ P A S S W O R D I N P U T | ↑ U P & D O W N ↓ PROGRAM MODE Pro9 | d-PS (Decimal-Point) | 100, 1.00, 10.0, 0.100 | 100 | |
| | | H-SL (High-Scale) | 10~999 | 100 | |
| | | SRd | -99 ~ 99 | 0 | |
| | | CHno (Channel number) | 0~128 | 1 | |
| | | PASS (Pass Word) | 0~99 | 00 | |
| | | End (End) | - | - | |
| | ↑ U P & D O W N ↓ ALARM MODE ALAr | ↑ U P & D O W N ↓ | LACH (LACH) | ON, OFF | ON |
| | | | EnS (Energizer) | ON, OFF | OFF |
| | | | ALP (Alarm Lamp) | ON, OFF | ON |
| | | | AL-1 (Alarm-1) | 1~Full range | 20%/F.R. |
| | | | 1H (1H) | H, L | H |
| | | | 1H00 (1H 00) | 0~99 | 00 |
| | | | AL1t (Alarm 1 Time Delay) | 0~60 | 1 |
| | | | AL1rL (Alarm 1 Relay) | ON, OFF | ON |
| | | | AL1bL (Alarm 1 Blink) | ON, OFF | OFF |
| | | | AL-2 (Alarm-2) | 1~Full range | 40%/F.R. |
| | | | 2H (2H) | H, L | H |
| | | | 2H00 (2H 00) | 0~99 | 00 |
| | | | AL2t (Alarm 2 Time Delay) | 0~60 | 1 |
| | | | AL2rL (Alarm 2 Relay) | ON, OFF | ON |
| AL2bL (Alarm 2 Blink) | ON, OFF | OFF | | | |
| AL-3 (Alarm-3) | 1~Full range | 50%/F.R. | | | |
| 3H (3H) | H, L | H | | | |
| 3H00 (3H 00) | 0~99 | 00 | | | |
| AL3t (Alarm 3 Time Delay) | 0~60 | 1 | | | |
| AL3rL (Alarm 3 Relay) | ON, OFF | ON | | | |
| AL3bL (Alarm 3 Blink) | ON, OFF | OFF | | | |
| End (End) | - | - | | | |

| Level1 | Level2 | Level3 | Level4(Selection Range) | Default | | |
|---|---|---|-----------------------------------|----------------------|---|-----|
| FUNC→ | FUNC→ | FUNC→ | FUNC→END | | | |
| ↑ U P & D O W N ↓ | ↑ U P & D O W N ↓ | <u>n-L</u> (Maintenance-Level) | 0 ~ Full range | 0 | | |
| | | <u>Undr</u> (Under) | ON / OFF | OFF | | |
| | | Option MODE <u>oPl</u> | <u>Eng</u> (Engineering) | ON / OFF | OFF | |
| | | <u>Eto</u> (Emergency-Timeout) | ON / OFF | OFF | | |
| | | <u>End</u> (End) | - | - | | |
| | ↑ U P & D O W N ↓ | ↑ U P & D O W N ↓ | <u>ErLY</u> (Trouble Relay) | ON / OFF | OFF | |
| | | | <u>ArLY</u> (Alarm Relay) | ON / OFF | OFF | |
| | | | Test MODE <u>tEst</u> | <u>RoUt</u> (mA out) | ON / OFF | OFF |
| | | | <u>0</u> or <u>100</u> (0 or 100) | 0 or 100(Flickering) | When it is set to ON, start from 100 When it is set to OFF, start from 0 | |
| | | | | | | |

7. Operation

7.1. Connection Check





- Referring to the terminal connection diagram as shown in Section 5, check the connection of operating power, connection with detection unit, etc.

* Power is AC85~260V, 50/60Hz. (Turn on after verifying the power supply)

7.2. Power ON

- Turn the switch on after verifying the voltage of power supply.
- Check if the power LED is turned on.
- Check if the "SELF" is displayed in FND of GTC-540 display unit.

7.3. Gas Concentration Display

| | |
|---|---|
|  | <ul style="list-style-type: none"> ➤ When the power of GTC-540A is turned on, current firm ware version is displayed. ➤ Current version is 17. |
|  | <ul style="list-style-type: none"> ➤ "SELF" will be flickering in FND of concentration display unit for 30 seconds and when the warming up is finished, it is ready to measure. ➤ In this moment if the trouble occurs in the equipment or detection unit, the trouble alarm will be activated |
|  | <ul style="list-style-type: none"> ➤ The gas concentration received from the detector is display in number in FND digital display. |
|  | <ul style="list-style-type: none"> ➤ When the detector is not connected or the value of current received from the detector is 10 % under the value set as high scale, the character "Undr" is displayed flickering with 1 second interval. ➤ Trouble LED is turned on and the Mars light is flickering sounding buzzer. ➤ If the "BZ-STOP" S/W is pressed, the Mars light is turned on and buzzer is stopped. |
|  | <ul style="list-style-type: none"> ➤ When the value of the current received from the detector is over 10% than the value set as high scale, the character "ovEr" will be displayed flickering with 1 second interval. ➤ LEDs for Alarm1, 2, 3 are turned on and the Mars light is flickering sounding buzzer. ➤ When the gas concentration is perceived above than the value set to alarm, the relevant alarm function will count the time set to maintain alarm and the alarm function will be activated if it is above than the time to maintain alarm. ➤ Alarm Relay is turned on if the time is over than the time to maintain alarm. ➤ When the alarm latch type is set to "ON" mode, the alarm and the gas concentration is maintained at maximum, and if the gas concentration is dropped |

| | |
|--|--|
| | <p>under the value set to alarm, it will not be reset and should be reset with "RESET S/W".</p> <ul style="list-style-type: none"> ➤ When the alarm latch type is set to "OFF" mode, the alarm function will be reset according to the gas concentration. |
|--|--|

7.4. Password Input

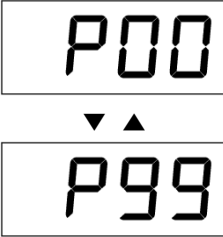





| | |
|---|--|
|  | <ul style="list-style-type: none"> ➤ If the "FUNC" S/W is pressed more than 2 seconds while the gas concentration is being displayed, the mode is changed to Password Input mode. ➤ If the 10 seconds is passed after operating final S/W manipulation in the Password Input mode, the display will be returned to gas concentration display automatically. ➤ When the "RESET" S/W is pressed, the mode will be returned to the gas concentration display mode. ➤ Demand to enter password. It is set to "P00" when it is shipped from the factory ➤ "P00" means that password is not entered. ➤ When the password is entered and the "FUNC" SW is pressed, each mode can be set. ➤ The mode can be verified in order of Program -> Alarm -> Option -> Test mode using "UP" S/W or "DOWN" S/W. |
|---|--|

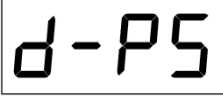
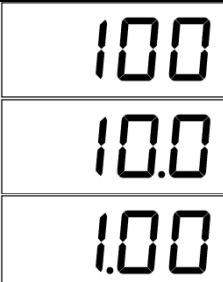

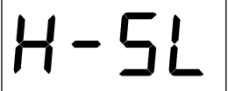
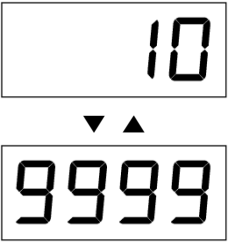
7.5. Program Data Setting

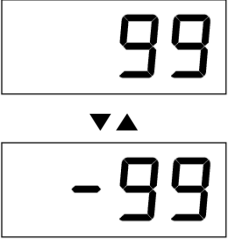
-. If the "FUNC" S/W is pressed using "UP" S/W or "DOWN" S/W after setting the password, you can enter the program data setting.

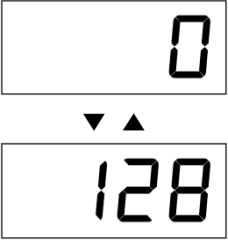
-. If 10 seconds are passed after manipulating final S/W in the program setting function, the display will be returned automatically to the gas concentration display mode.





| | |
|---|--|
|  | <ul style="list-style-type: none"> ➤ If "FUNC" S/W is pressed, the mode is changed to Program Mode. ➤ If "RESET" S/W is pressed, the mode is returned to gas concentration display mode. |
|  | <ul style="list-style-type: none"> ➤ This is the function to set the position of decimal point, the first function of program data setting functions. ➤ If "FUNC" S/W is pressed, the mode is changed to decimal point setting mode. ➤ If "RESET" S/W is pressed, the mode is returned to Program Mode. |
|  | <ul style="list-style-type: none"> ➤ Use the decimal point when it is necessary according to the measuring range and when the decimal point is set, the decimal point will be changed as shown in left side whenever the "UP" S/W or "DOWN" S/W is pressed. (Default: 100) Ex)100, 10.0, 1.00, 0.100 ➤ The position of decimal point is set if "FUNC" S/W is pressed when the desired decimal point position is displayed and the screen is changed for next item. ➤ When "RESET" S/W is pressed, the mode is returned to Program Mode |



| | |
|---|--|
|  | <ul style="list-style-type: none"> ➤ This is the High Scale setting function, which is to set maximum value of gas concentration. |
|  | <ul style="list-style-type: none"> ➤ The High Scale value is set to the range provided by domestic law when shipping. ➤ If "FUNC" S/W is pressed, the mode is changed to High Scale setting mode. ➤ If "RESET" S/W is pressed, the mode is returned to Program Mode. |
|  | <ul style="list-style-type: none"> ➤ High Scale value is the function to change the set value according to the measuring range and the Scale value is increased or decreased whenever "UP" S/W or "DOWN" S/W is pressed. (Default 100) ➤ If the "FUNC" S/W is pressed when the desired High Scale value is displayed, the High Scale value is set and the screen is changed for next item. ➤ If "RESET" S/W is pressed, the mode is returned to Program Mode. ➤ This setting mode is set to same measuring range with the gas detector when shipping. <p>Ex) When the range is set to 100 When displaying for 4 mA/DC . displays 0. When displaying for 20 mA/DC . displays 100</p> |
|  | <ul style="list-style-type: none"> ➤ This is the function to set the value of SAD, which is the function to compensate the error of the measured value occurred in the detection unit. ➤ When "FUNC" S/W is pressed, the mode is changed to SAD value setting mode. ➤ If "RESET" S/W is pressed, the mode is returned to Program Mode. |
|  | <ul style="list-style-type: none"> ➤ This is the function to set the value of SAD and the value of SAD is increased or decreased whenever "UP" S/W or "DOWN" S/W is pressed and when the value is negative, it is displayed by adding "-" sign in front of first number. (Default 0) ➤ If "FUNC" S/W is pressed when the desired SAD value is displayed, the SAD value is set and the screen is changed for next item. ➤ If "RESET" S/W is pressed, the mode is returned to Program Mode. <p>(Ex) If the error of detector output is -2, although the actual display should be instructed -2 but displays with 0 by compensating 2 to the value set as SAD.</p> |
|  | <ul style="list-style-type: none"> ➤ This is Channel Number setting function, which is set the number recognized by Control Unit. ➤ If "FUNC" S/W is pressed, the display is changed to Channel Number setting mode. ➤ If "RESET" S/W is pressed, the mode is returned to Program Mode. |
|  | <ul style="list-style-type: none"> ➤ Channel Number mode is the mode entering the unique number of Control unit so that the operation of each control unit can be checked in PC or other equipments and the Address No. is increased or decreased whenever "UP" S/W or "DOWN" S/W is pressed. (Default 1) ➤ If "FUNC" S/W is pressed when the desired Address No is displayed, the Address No. is set and the screen is changed for next item. ➤ Channel No. is set to "1" when shipping and it needs to be entered when the communication function is used. In case of using 2 control units or more, different No. should be entered in order not to overlap the Channel No. |
|  | <ul style="list-style-type: none"> ➤ This is the function to set the password. ➤ If "FUNC" S/W is pressed, the mode is changed to password setting mode ➤ If "RESET" S/W is pressed, the mode is returned to Program Mode. |



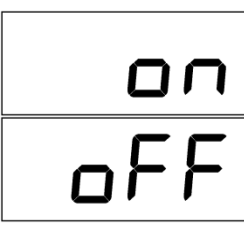

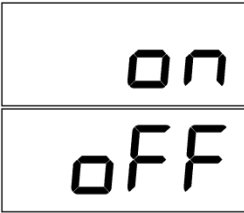

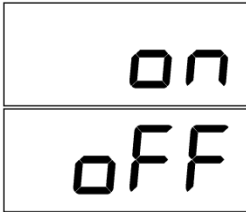
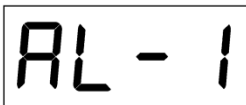

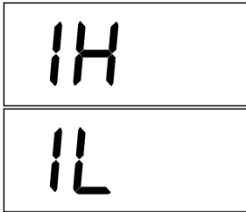
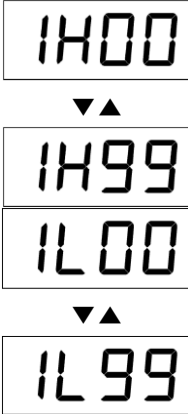

| | |
|---|---|
|  | <ul style="list-style-type: none"> ➤ The password is increased or decreased whenever "UP" S/W or "DOWN" S/W is pressed. (Default P00) |
|  | <ul style="list-style-type: none"> ➤ If "FUNC" S/W is pressed when the desired password is displayed, the password is set and the screen is changed for next item. ➤ If "RESET" S/W is pressed, the mode is returned to Program Mode. |
|  | <ul style="list-style-type: none"> ➤ The message notifying that the setting functions are completed is displayed with "END" for 2 seconds and the display is returned to gas concentration display mode. |

7.6. Alarm Data Setting

- . After setting password, change the mode using "UP" S/W or "DOWN" S/W and press "FUNC" S/W.
- . When 10 seconds are passed after manipulating final S/W in the alarm setting mode, the display will be return to gas concentration display mode automatically.

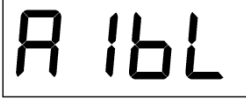
| | |
|---|---|
|  | <ul style="list-style-type: none"> ➤ The values for Alarm1, Alarm2, and Alarm3 can be set, ➤ If "FUNC" S/W is pressed, the mode is changed to alarm setting mode. ➤ If "RESET" S/W is pressed, the mode is returned to the gas concentration display mode. |
|  | <ul style="list-style-type: none"> ➤ This is the function to set Alarm Latch Type. ➤ If "FUNC" S/W is pressed, the mode is changed to the mode to set alarm latch type. ➤ If "RESET" S/W is pressed, the mode is returned to the alarm setting mode. |
|  | <ul style="list-style-type: none"> ➤ This is mode to change the alarm reset type and "On" and "OFF" modes will be changed whenever "UP" S/W or "DOWN" S/W is pressed. ➤ If "FUNC" S/W is pressed when the desired Alarm Latch Type is displayed, Alarm Latch Type is set and the screen is changed for next item. ➤ If "RESET" S/W is pressed, the mode is returned to Alarm Setting Mode. ➤ There are two Alarm Latch modes; "ON" and "OFF" mode, and OFF mode reset the alarm automatically and in ON mode, the user should press "RESET" S/W to reset the alarm. |
|  | <ul style="list-style-type: none"> ➤ This is the function to set the Energizer mode of Alarm Relay and Fault Relay ➤ If "FUNC" S/W is pressed, the mode is changed to the Energizer mode. ➤ If "RESET" S/W is pressed, the display is returned to the Alarm Setting mode. |
|  | <ul style="list-style-type: none"> ➤ Energizer mode is set to ON/OFF mode using "UP" S/W or "DOWN" S/W ➤ If it is set to ON, it is under normal open (NO) condition. ➤ If it is set to OFF, it is under normal close (NC) condition. ➤ If "FUNC" S/W is pressed when the desired Energizer mode is displayed, the Energizer mode is set and the screen is changed for next item. ➤ If "RESET" S/W is pressed, the mode is returned to the Alarm Setting mode. |

| | |
|---|--|
|  | <ul style="list-style-type: none"> ➤ This is the mode to set the external Mars light and the warning light to operate for the desired alarm. ➤ If "FUNC" S/W is pressed, the mode is changed to Alarm Lamp setting mode. ➤ If "RESET" S/W is pressed, the mode is returned to Alarm Setting mode. |
|  | <ul style="list-style-type: none"> ➤ Set ON and OFF function using "FUNC" S/W by selecting desired alarm using "UP" S/W and "DOWN" S/W. ➤ Default is set to "on". ➤ When the alarm is activate, Mars light is turned on if the alarm Lamp is set to ON, and Mars light is flickering if the alarm lamp is set to OFF. ➤ If "FUNC" S/W is pressed when the desired ALP is displayed, ALP is set and the screen is changed for next item ➤ If "RESET" S/W is pressed, the mode is returned to Alarm Setting mode. |
|  | <ul style="list-style-type: none"> ➤ Alarm 1 setting message, which is the function to set the value for Alarm 1 is displayed with "AL-1". ➤ If "FUNC" S/W is pressed, the mode is changed to Alarm 1 setting mode. ➤ If "RESET" S/W is pressed, the mode is returned to Alarm Setting mode. |
|  | <ul style="list-style-type: none"> ➤ This is the function to change the value set for Alarm1. Maximum value can be set to High Scale value and the Alarm 1 value will be increased or decreased whenever "UP" S/W or "DOWN" S/W is pressed. ➤ If "FUNC" S/W is pressed when the desired Alarm 1 value is displayed, Alarm 1 value is set and the screen is changed for next item ➤ If "RESET" S/W is pressed, the mode is returned to Alarm Setting mode. <p>(Default: Alarm1 = 20(F/S 20%), Alarm2 = 40(F/S 40%), Alarm3 = 50(F/S 50%))</p> |
|  | <ul style="list-style-type: none"> ➤ Alarm level is set to the concentration provide by domestic law when shipping ➤ This is the mode to set the direction of Alarm1 operation and "H" or "L" is displayed whenever "UP" S/W or "DOWN" S/W is pressed ➤ "H" mode is to activate when the gas value is equal or greater than the value set to Alarm 1 and "L" mode is to activate when the gas value is equal or below than the value set to Alarm. ➤ If "FUNC" S/W is pressed when the desired mode is displayed, the mode is set and the screen is changed for next item ➤ If "RESET" S/W is pressed, the mode is returned to Alarm Setting mode. |
|  | <ul style="list-style-type: none"> ➤ This is the mode to set the Dead Band value, which Alarm1 is activated and the value will be increased or decreased whenever "UP" S/W or "DOWN" S/W is pressed. (Default 0) ➤ When Alarm is set to "H" mode, Alarm 1 is activated at the value equal or higher than Alarm value plus dead Band value and deactivated at the value equal or below than Alarm value minus Dead Band value. ➤ When Alarm1 is set to "L", Alarm 1 is activated at the value equal or below than Alarm value minus Dead Band value and deactivated at the value equal or higher than Alarm 1 value plus Dead Band value. ➤ If "FUNC" S/W is pressed when the desired Alarm 1 Dead Band value is displayed, Alarm 1 Dead Band value e is set and the screen is changed for next item ➤ If "RESET" S/W is pressed, the mode is returned to Alarm Setting mode. |

| | |
|--|--|
|  | <ul style="list-style-type: none"> ➤ This is the function to set the delay time of Alarm1. ➤ This is the function to prevent momentary malfunction of the detector by external shock or impact of the noise. ➤ If "FUNC" S/W is pressed, the mode is changed to the function to set the delay time of Alarm 1. ➤ If "RESET" S/W is pressed, the mode is returned to Alarm Setting mode. |
|   | <ul style="list-style-type: none"> ➤ The delay time of Alarm is increased and decreased in unit of second whenever "UP" S/W or "DOWN" S/W is pressed. (Default 1) Ex) When the value set to alarm is 20%LEL and delay Time is 5sec, the alarm will be activated when the measured value higher than the value set to alarm based on 20%LEL is maintained more than 5 seconds and is not activated when the measured value is dropped below the value set to alarm within 5 seconds ➤ If "FUNC" S/W is pressed when the desired delay time of Alarm 1 is displayed, the delay time of Alarm 1 is set and the screen is changed for next item ➤ If "RESET" S/W is pressed, the mode is returned to Alarm Setting mode. |
|  | <ul style="list-style-type: none"> ➤ This is the function to set the contact output of Alarm1. ➤ If "FUNC" S/W is pressed, the mode is changed to Alarm 1 contact output setting mode. ➤ If "RESET" S/W is pressed, the mode is returned to Alarm Setting mode. |
|   | <ul style="list-style-type: none"> ➤ This is the mode to change the Alarm1 contact output and the mode will be change to "ON" or "OFF" whenever "UP" S/W or "DOWN" S/W is pressed ➤ Alarm1 contact output mode has two modes of "ON" and "OFF" and Alarm 1 contact output is not activate in the OFF mode but in the ON mode. ➤ If "FUNC" S/W is pressed when the desired Alarm 1 contact output is displayed, Alarm 1 contact output. ➤ If "RESET" S/W is pressed, the mode is returned to Alarm Setting mode. |
|  | <ul style="list-style-type: none"> ➤ This is the function to set the Alarm 1 blink output, which Alarm 1 contact output is switched to ON/OFF at 1 second interval while the buzzer is sounding. ➤ If "FUNC" S/W is pressed, the mode is changed to Alarm 1 blink output setting mode. ➤ If "RESET" S/W is pressed, the mode is returned to Alarm Setting mode. |
|   | <ul style="list-style-type: none"> ➤ This is the mode to change the Alarm1 blink output and the mode will be changed to "ON" or "OFF" whenever "UP" S/W or "DOWN" S/W is pressed ➤ Alarm1 blink output mode has two modes of "ON" and "OFF" and Alarm 1 blink output is not activated in the "OFF" mode but in the "ON" mode(However, Alarm contact output is set to "ON") ➤ If "FUNC" S/W is pressed when the desired Alarm 1 blink output mode is displayed, Alarm 1 blink output mode is set and the screen is changed for next item . ➤ If "RESET" S/W is pressed, the mode is returned to Alarm Setting mode. |
|  | <ul style="list-style-type: none"> ➤ The message notifying that the setting functions are finished is displayed with "END" for 2 seconds and the mode is returned to gas concentration display mode |







*** The functions for Alarm2 and Alarm3 are same as Alarm 1**

7.7. Option Setting

-. You can enter to this mode when pressing "FUNC" key by moving "UP" S/W or "DOWN" S/W after setting password.

-. If 10 seconds are passed after manipulating final S/W in the Option Setting mode, the mode will be returned to Gas Concentration Display mode automatically.

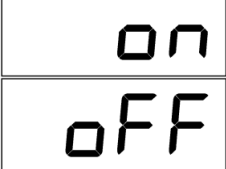
- Since the most of the functions in Option Mode are the functions set in the factory, these functions should not be modified and if it is unavoidable, it should be made with the support of Gastron.

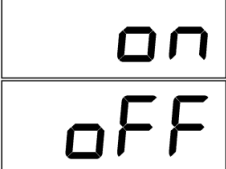
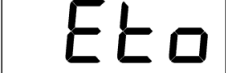
| | |
|--|---|
|  | <ul style="list-style-type: none"> ➤ This is mode to set the optional functions. ➤ If "FUNC" S/W is pressed, the mode is changed to Option Setting mode. ➤ If "RESET" S/W is pressed, the mode is returned to the gas concentration display mode. |
|  | <ul style="list-style-type: none"> ➤ This is the mode to set the display and the output value in FND when the equipment is under the maintenance mode. ➤ If "FUNC" S/W is pressed, the mode is changed to n-L setting mode. ➤ If "RESET" S/W is pressed, the mode is returned to Option Setting mode. |
|  Full Range | <ul style="list-style-type: none"> ➤ It can be set within the full range with "UP" S/W or "DOWN" S/W. (Default: 0, Oxygen: 20.9(Ex) Set value 0 : 4mA, Full Range : 20mA) ➤ If "FUNC" S/W is pressed when the desired n-L value is displayed, the selection is set and the screen is changed for next item ➤ If "RESET" S/W is pressed, the mode is returned to Option Setting mode. |
|  | <ul style="list-style-type: none"> ➤ This is function to set of Undr is displayed in FND when the value is below than - 10% out of the value less than 0 ➤ If "FUNC" S/W is pressed, the mode is changed to Under setting mode. ➤ If "RESET" S/W is pressed, the mode is returned to Option Setting mode. |
|  | <ul style="list-style-type: none"> ➤ "On" or "OFF" can be set using "UP" S/W or "DOWN" S/W and if it is set to "ON", UNDER function can be used. (Default OFF) ➤ If "FUNC" S/W is pressed when the desired item is displayed, the selection is set and the screen is changed for next item ➤ If "RESET" S/W is pressed, the mode is returned to Option Setting mode. |
|  | <ul style="list-style-type: none"> ➤ It displays the raw measured value from -XXXX to +YYYY without processing. ➤ If "FUNC" S/W is pressed, the mode is changed to "Under" Setting mode. ➤ If "RESET" S/W is pressed, the mode is returned to Option Setting mode. (This mode is used for Test mode only and not used in the actual field) |
|  | <ul style="list-style-type: none"> ➤ ON/OFF can be set with "UP" S/W or "DOWN" S/W and if it is set to ON, this function can be used. (Default OFF) ➤ If "FUNC" S/W is pressed when the desired item is displayed, the selection is set and the screen is changed for next item ➤ If "RESET" S/W is pressed, the mode is returned to Option Setting mode. |
|  | <ul style="list-style-type: none"> ➤ This is to set the Emergency Time Out. In the maintenance mode, you can decide to set time. |



| | |
|--|--|
| | <ul style="list-style-type: none"> ➤ If "FUNC" S/W is pressed, the mode is changed to Emergency Time Out setting mode. ➤ If "RESET" S/W is pressed, the mode is returned to Option Setting mode. |
| <div style="border: 1px solid black; padding: 5px; text-align: center; margin-bottom: 5px;">on</div> <div style="border: 1px solid black; padding: 5px; text-align: center;">oFF</div> | <ul style="list-style-type: none"> ➤ ON/OFF can be set with "UP" S/W or "DOWN" S/W and if it is set to ON, the maintenance mode time is set to 30 minutes and if it is set to OFF, the maintenance mode is maintained continuously without limitation (Default OFF) ➤ If "FUNC" S/W is pressed when the desired item is displayed, the selection is set and the screen is changed for next item ➤ If "RESET" S/W is pressed, the mode is returned to Option Setting mode. |
| <div style="border: 1px solid black; padding: 5px; text-align: center;">End</div> | <ul style="list-style-type: none"> ➤ The message notifying that the setting functions are finished is displayed with "END" for 2 seconds and the mode is returned to gas concentration display mode |

7.8. Test Mode Setting

-. You can enter to this mode when pressing "FUNC" key by moving "UP" S/W or "DOWN" S/W after setting password.

- . -. If 10 seconds are passed after manipulating final S/W in the Test mode, the mode will be returned to Gas Concentration Display mode automatically

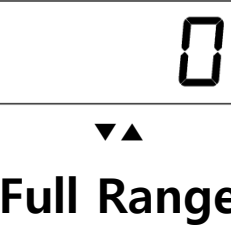

| | |
|--|---|
| <div style="border: 1px solid black; padding: 5px; text-align: center;">tEst</div> | <ul style="list-style-type: none"> ➤ Test mode is the function to test the detector sensor without injecting gas, the user can set the gas concentration by pressing "UP" S/W or "DOWN" S/W and Alarm function is operating normally with the concentration value set by the user ➤ If "FUNC" S/W is pressed, the mode is changed to Test Setting mode. ➤ If "RESET" S/W is pressed, the mode is returned to the gas concentration display mode. |
| <div style="border: 1px solid black; padding: 5px; text-align: center;">tRLY</div> | <ul style="list-style-type: none"> ➤ This is the mode to set Trouble Relay Test operation to ON/OFF. ➤ If "FUNC" S/W is pressed, the mode is changed to Trouble Relay setting mode. ➤ If "RESET" S/W is pressed, the mode is returned to Test Setting mode. |
| <div style="border: 1px solid black; padding: 5px; text-align: center; margin-bottom: 5px;">on</div> <div style="border: 1px solid black; padding: 5px; text-align: center;">oFF</div> | <ul style="list-style-type: none"> ➤ ON/OFF can be set with "UP" S/W or "DOWN" S/W and if it is set to ON, the Trouble Relay function can be used. (Default OFF) ➤ If "FUNC" S/W is pressed when the desired item is displayed, the selection is set and the screen is changed for next item ➤ If "RESET" S/W is pressed, the mode is returned to the Test Setting mode. |
| <div style="border: 1px solid black; padding: 5px; text-align: center;">ARLY</div> | <ul style="list-style-type: none"> ➤ This is the mode to set Alarm Relay Test operation to ON/OFF. ➤ If "FUNC" S/W is pressed, the mode is changed to Alarm Relay setting mode. ➤ If "RESET" S/W is pressed, the mode is returned to Test Setting mode. |
| <div style="border: 1px solid black; padding: 5px; text-align: center; margin-bottom: 5px;">on</div> <div style="border: 1px solid black; padding: 5px; text-align: center;">oFF</div> | <ul style="list-style-type: none"> ➤ ON/OFF can be set with "UP" S/W or "DOWN" S/W and if it is set to ON, Alarm Relay function can be used. (Default OFF) ➤ If "FUNC" S/W is pressed when the desired item is displayed, the selection is set and the screen is changed for next item. ➤ If "RESET" S/W is pressed, the mode is returned to Test Setting mode. |







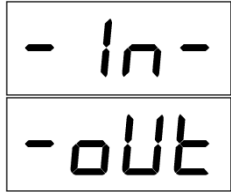

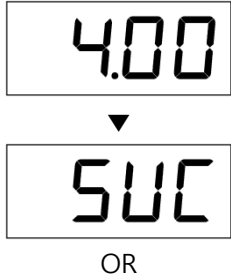

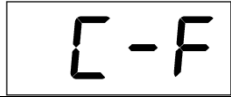

| | |
|---|--|
|  | <ul style="list-style-type: none"> ➤ This is the mA Output Signal Test Mode. ➤ If "FUNC" S/W is pressed, the mode is changed to mA Output Setting mode. ➤ If "RESET" S/W is pressed, the mode is returned to Test Setting mode. |
|  | <ul style="list-style-type: none"> ➤ ON/OFF can be set with "UP" S/W or "DOWN" S/W and if it is set to ON, mA OUT function can be used. (Default OFF) ➤ If "FUNC" S/W is pressed when the desired item is displayed, the selection is set and the screen is changed for next item ➤ If "RESET" S/W is pressed, the mode is returned to Test Setting mode. |
|  | <ul style="list-style-type: none"> ➤ If Aout is OFF, it starts from 0 and although the value in FND is changed with "UP" S/W or "DOWN" S/W, mA is not displayed. (Default 3mA) ➤ If Aout is ON, the value of FND is displayed from 100, the output current is 20mA and can be changed with "UP" S/W or "DOWN" S/W (FND: 0~100, mA : 4mA~20mA) ➤ If "FUNC" S/W is pressed, the mode is returned to Test Setting mode ➤ If "RESET" S/W is pressed, the mode is returned to Test Setting mode . |

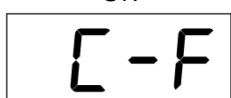
7.9. Maintenance Function Setting

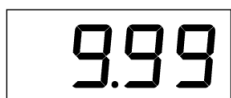
-. You can enter to Maintenance Setting mode when pressing "RESET" S/W and "BZ-STOP" S/W more than 2 seconds in the gas concentration display mode.

-. To return to gas concentration display mode in the maintenance mode, the "RESET" S/W should be pressed

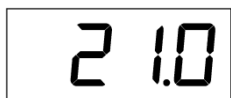
| | |
|---|---|
|  | <ul style="list-style-type: none"> ➤ This is the mode to select the input and output current values, which are the basis of Channel Unit and "In" or "oUt" is displayed whenever "UP" S/W or "DOWN" S/W is pressed ➤ If "FUNC" S/W is pressed when the desired mode is displayed, and the screen is changed for relevant mode ➤ "In" is mode to set the current input value and "oUt" is the mode to set the current output value ➤ If "RESET" S/W is pressed, the mode is returned to the gas concentration display mode. |
|  | <ul style="list-style-type: none"> ➤ This is the case selecting "In" and is the mode to enter and set current of 4mA ➤ If "FUNC" S/W is pressed, the mode is changed to the mode displaying the current input value in number. ➤ If "RESET" S/W is pressed, the mode is returned to the gas concentration display mode. |
|  | <ul style="list-style-type: none"> ➤ This is the mode displaying the value converted in the processor by supplying the current of 4mA to (mA) terminal. ➤ If "FUNC" S/W is pressed when the number is displayed stably, SUS (Success) is displayed when the current within normal range is supplied and the screen is changed for next item. ➤ If the current other than normal range is entered, C-F (Calibration-Fail) is displayed and the current value entered is displayed. Verify the current entered and check again by pressing "FUNC" S/W. |

| | |
|--|---|
|  | <ul style="list-style-type: none"> ➤ If "RESET" S/W is pressed, the mode is returned to the gas concentration display mode. |
|  | <ul style="list-style-type: none"> ➤ This is the mode to set entering current of 20mA ➤ If "FUNC" S/W is pressed, the mode is changed to the mode displaying the current value entered in number ➤ If "RESET" S/W is pressed, the mode is returned to the gas concentration display mode. |
|  <p style="text-align: center;">▼</p>  <p style="text-align: center;">OR</p>  | <ul style="list-style-type: none"> ➤ This is the mode displaying the value converted in the processor by entering the current of 20mA to (mA) terminal. ➤ If "FUNC" S/W is pressed when the number is displayed stably, SUS (Success) is displayed when the current within normal range is supplied and the screen is changed for next item. ➤ If the current other than normal range is entered, C-F (Calibration-Fail) is displayed and the current value entered is displayed. Verify the current entered and check again by pressing "FUNC" S/W. |
|  <p style="text-align: center;">▼▲</p>  | <ul style="list-style-type: none"> ➤ This is the mode after selecting "oUt" and followed the input current mode and to set the output current of 4mA. (Default 4.00) ➤ Connect the ampere meter to the 4~20mA output terminal and if press "FUNC" S/W when the value of ampere meter and the value displayed in FND are same, the output current is set and the screen is changed for next item ➤ If "RESET" S/W is pressed, the mode is returned to the gas concentration display mode. |
|  <p style="text-align: center;">▼▲</p>  | <ul style="list-style-type: none"> ➤ This is the mode to set the 20mA output current. (Default 20.00) ➤ The value in FND is displayed in 0.5 seconds unit. ➤ Connect the ampere meter to the 4~20mA output terminal and if press "FUNC" S/W when the value of ampere meter and the value displayed in FND are same, the output current is set and the screen is changed for next item ➤ If "RESET" S/W is pressed, the mode is returned to the gas concentration display mode. |
|  <p style="text-align: center;">▼▲</p>  | <ul style="list-style-type: none"> ➤ This is the mode to test the output current after completing the calibration. (Default 4.0) ➤ The output current from 3.0mA to 21.0mA can be checked using "UP" S/W and "DOWN" S/W. ➤ If "FUNC" S/W is pressed after completing the check, the screen is changed for next item ➤ If "RESET" S/W is pressed, the mode is returned to the gas concentration display mode. |
|  | <ul style="list-style-type: none"> ➤ The message notifying that the setting functions are finished is displayed with "END" for 2 seconds and the mode is returned to gas concentration display mode |

7.10. Test Function Setting

- . You can enter to this mode when pressing “FUNC” key by moving “UP” S/W or “DOWN” S/W more than 2 seconds in the gas concentration display mode.
- . If 30 minutes are passed after manipulating last S/W in the Test mode, the mode will be returned to Gas Concentration Display mode automatically.

| | |
|--|--|
|  <p>Full Range</p> | <ul style="list-style-type: none"> ➤ In Test mode, the gas concentration is displayed flickering. ➤ This mode is the function to be able to test the detector sensor in the Channel Unit without injecting gas, the user can set the gas concentration by pressing “Test” S/W and Alarm function is operated normally with the concentration value set by the user ➤ If “FUNC” S/W is pressed more than 2 seconds, the screen is changed to FND/ LED/ Bar LED Test mode ➤ 3-Color bar graph LED displays green, orange and red color alternatively with 0.5 seconds interval and each function LED is flickered in 0.5 seconds interval. ➤ If “RESET” S/W is pressed, the mode is returned to the gas concentration display mode. |
|--|--|

7.11. DOWN (Stand-by) Mode

- . You can enter to the maintenance mode when pressing “DOWN (Stand-by)” S/W more than 2 seconds in the gas concentration display mode
- . If ETO (Emergency Time Out) is set to On in the Option Setting mode, the mode will be returned to gas concentration display mode automatically Option when 30 minutes are passed
- . If ETO (Emergency Time Out) is set to OFF, “DOWN” (Stand-by) S/W should be pressed more than 2 second to return to gas concentration display mode.

| | |
|---|---|
|  | <ul style="list-style-type: none"> ➤ In the Down mode, STD-BY LED is flickered and all the rests functions of GTC-540A are operational except the Trouble/ Alarm Relay contact output. ➤ If “DOWN (Stand-by)” S/W is pressed more than 2 seconds, the mode is returned to gas concentration display mode. |
|---|---|

7.12. Factory Initialization Function

- . You can enter to this mode when turn on power while pressing “FUNC” S/W and “DOWN” S/W
- . Factory Initialization is the mode to initialize the data of the product to the data when shipping.
 - ***Since Factory Initialization is mostly the functions set in the factory, it should not be modified and if it is unavoidable, it should be assisted by Gastron***

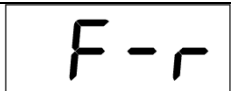
| | |
|---|--|
|  | <ul style="list-style-type: none"> ➤ This the mode to initialize the data currently stored to the data at the time of shipping. |
|---|--|

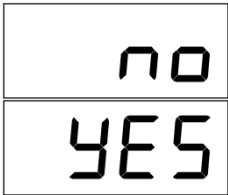
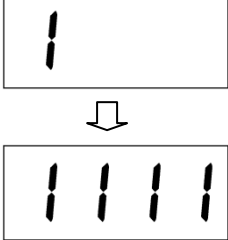
| | |
|---|--|
| <p>Picture 1</p> | <ul style="list-style-type: none"> ➤ If "RESET" S/W is pressed, the mode is returned to the gas concentration display mode. |
|  | <ul style="list-style-type: none"> ➤ Press "FUNC" S/W to enter to the mode. ➤ Yes/No can be selected with "UP" S/W or "DOWN" S/W and Yes is selected, Factory Initialization function can be used (Default No) ➤ If "RESET" S/W is pressed, the mode is returned to the gas concentration display mode. |
|  | <ul style="list-style-type: none"> ➤ Since this is the function using "FUNC" S/W, it may occur the case that S/W is pressed consecutively ➤ To prevent that, if "FUNC" S/W is operated when selecting Yes/no, in the FND, "1" -> "11" -> "111" -> "1111" is displayed from left side in 0.5 seconds interval ➤ When "YES" is selected, the initialization is completed and the mode is returned to the gas concentration display mode. ➤ When "No" is selected, the mode is returned to the gas concentration display mode without performing initialization ➤ If "RESET" S/W is pressed, the mode is returned to the gas concentration display mode without displaying anything on FND. |

7.13. Calibration Data Initialization

- You can enter to this mode when the power is turned on while pressing "FUNC" S/W and "DOWN" S/W.
- Calibration Initialization is the function to the calibration values only out of the product setting to the factory setting.

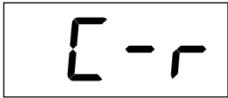
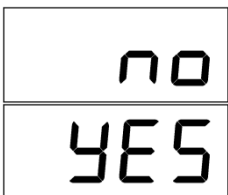
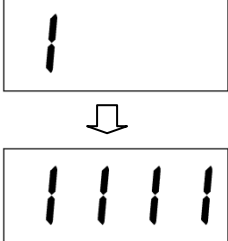
| | |
|---|--|
|  | <ul style="list-style-type: none"> ➤ This is mode to set the calibration data only out of the data currently stored to factory setting ➤ If "RESET" S/W is pressed, the mode is returned to the gas concentration display mode. |
|  | <ul style="list-style-type: none"> ➤ Enter to this mode by pressing "FUNC" S/W. ➤ Yes/No can be selected with "UP" S/W or "DOWN" S/W and if "Yes" is selected, Calibration Initialization can be used (Default No) ➤ If "RESET" S/W is pressed, the mode is returned to the gas concentration display mode. |
|  | <ul style="list-style-type: none"> ➤ Since this is the function using "FUNC" S/W, it may occur the case that S/W is pressed consecutively ➤ To prevent that, if "FUNC" S/W is operated when selecting Yes/no, in the FND, "1" -> "11" -> "111" -> "1111" is displayed from left side in 0.5 seconds interval ➤ When "YES" is selected, the initialization is completed and the mode is returned to the gas concentration display mode. ➤ When "No" is selected, the mode is returned to the gas concentration display mode without performing initialization ➤ If "RESET" S/W is pressed, the mode is returned to the gas concentration display mode without displaying anything on FND. |

8. RS485 MODBUS Communication Data

8.1. 4~20mA Current Output

| Current Output | Explanation |
|----------------|---------------------------------------|
| 0mA | Fault Mode, Under Range(-10% or less) |
| 3mA | Maintenance Mode |
| 4~20mA | Normal Operation (0~100%) |
| 22mA | OVER Range(110% or more) |

[Table 4 Analog 4~20mA Output]

8.2. 485 MODBUS Interface

8.2.1. RS-485 Communication Setting

- 1) Baud rate: 9600 bps
- 2) Data bits: 8bits
- 3) Stop bit: 1bit
- 4) Parity: Even

8.2.2. Address Structure

| Description | Address | Bits | Description |
|----------------------------|---------|---------|--|
| Measured Gas Concentration | 30001 | BIT15~0 | Measure gas value (integer type / Decimal Point is not considered) |
| High Scale value | 30002 | BIT15~0 | High Scale value (integer type / Decimal Point is not considered) |
| Gas detector value | 10000 | BIT0 | Alarm 1 Active |
| | | BIT1 | Alarm 2 Active |
| | | BIT2 | Alarm 3 Active |
| | | BIT3 | Maintenance Mode |
| | | BIT4 | Test Mode |
| | | BIT5 | Calibration Mode |
| | | BIT6 | Reserved |
| | | BIT7 | Toggle Bit(Bit reversal in 2 Sec interval) |
| External Test | 3 | BIT0~7 | Set Gas detector Test Mode |
| External Reset | 2 | BIT0~7 | End Gas detector Test Mode |

9. Outside View and Dimensions

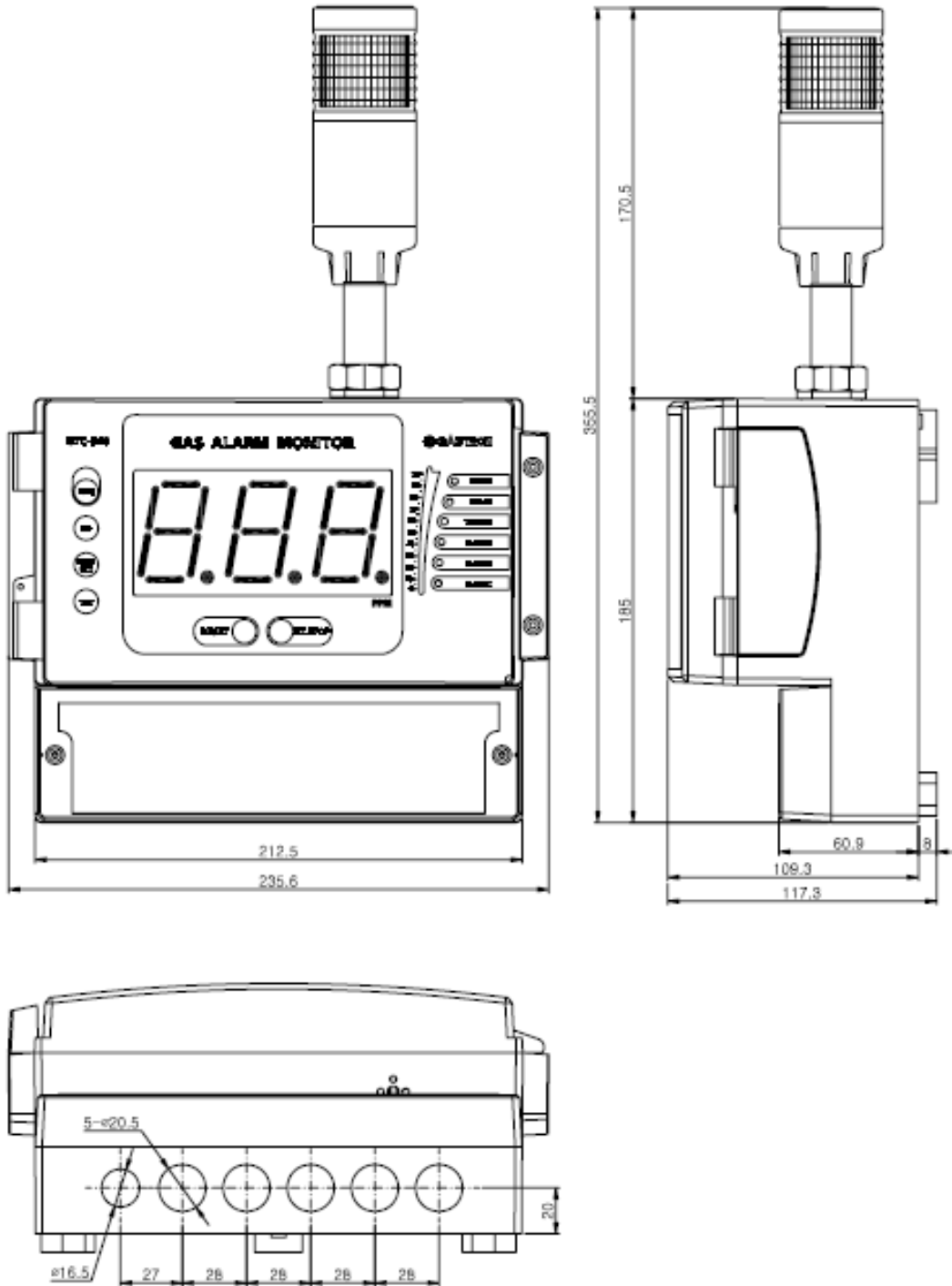

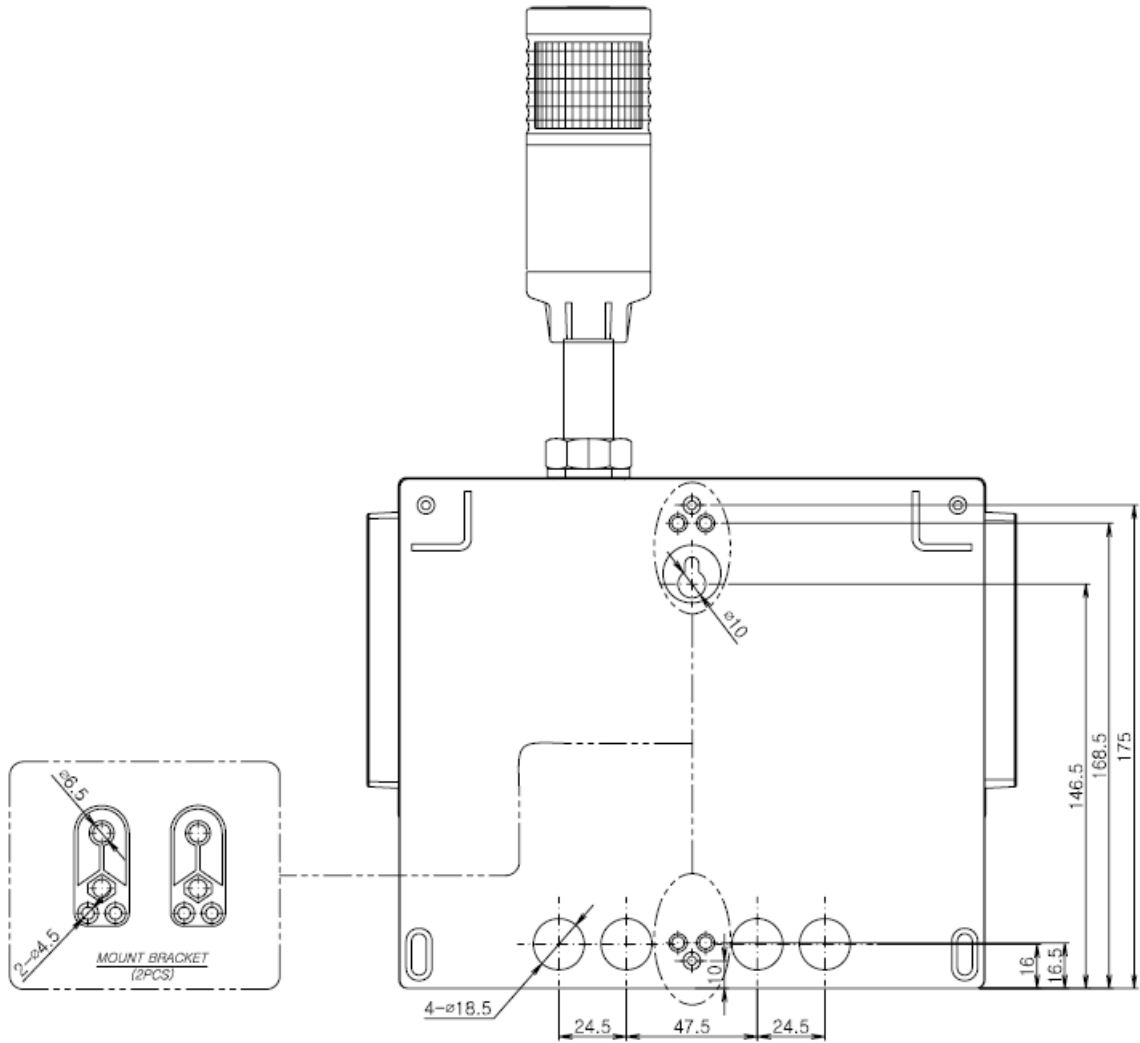

10. Revision History

| Version | Contents | Date |
|---------|--|---------------|
| 0 | * Initial Edition of Manual | Aug 25 , 2011 |
| 1 | Change Main PCB Layout and add the functions | Jan 15, 2014 |
| 2 | Add the functions | Sep 01, 2014 |
| END | | |

This product and product manual are subject to change for the improvement of product performance and the convenience of use without prior notice.



Gastron Co., Ltd.

Gastron Co., Ltd. 18-8 Dogeumdanji 1-gil (Palgok 2-dong), Sangnok-gu,
Ansan City, Gyeonggi-do

Tel: 031-4900-800

Fax: 031-4900-801

<http://www.gastron.com>

gastron@gastron.com